



Nozzle Performance

Pressure psi	Nozzle	Radius ft.	Flow GPM	Square Precip. in/hr	Triangular Precip. in/hr
	0.75	15	0.54	0.23	0.27
	1.0	20	0.77	0.18	0.21
25	1.5	23	1.06	0.19	0.22
	2	27	1.40	0.18	0.21
	3	29	2.17	0.25	0.29
	4	31	2.97	0.30	0.34
	0.75	17	0.67	0.22	0.26
	1.0	21	0.92	0.20	0.23
35	1.5	23	1.28	0.23	0.27
	2	27	1.69	0.22	0.26
	3	31	2.60	0.26	0.30
	4	33	3.58	0.32	0.37
	0.75	17	0.77	0.26	0.30
	1.0	21	1.06	0.23	0.27
45	1.5	24	1.48	0.25	0.29
	2	27	1.93	0.30	0.35
	3	31	3.00	0.32	0.37
	4	35	4.13	0.32	0.37
	0.75	18	0.85	0.25	0.29
	1.0	22	1.18	0.23	0.27
55	1.5	24	1.65	0.28	0.32
	2	28	2.15	0.26	0.30
	3	32	3.25	0.31	0.35
	4	35	4.60	0.36	0.42

Metric Data

Pressure bars	Nozzle	Radius m	Flow m ³ /hr	Square Precip. mm/hr	Triangular Precip. mm/hr
	0.75	4.57	0.12	5.87	6.78
	1.0	6.10	0.17	4.68	5.40
1.72	1.5	7.01	0.24	4.90	5.66
	2	8.23	0.32	4.68	5.40
	3	8.84	0.49	6.30	7.27
	4	9.45	0.67	7.56	8.73
	0.75	5.18	0.15	5.67	6.55
	1.0	6.40	0.21	5.10	5.89
2.41	1.5	7.01	0.29	5.92	6.83
	2	8.23	0.38	5.65	6.53
	3	9.45	0.59	6.62	7.64
	4	10.06	0.81	8.03	9.27
	0.75	5.18	0.17	6.52	7.53
	1.0	6.40	0.24	5.88	6.79
3.10	1.5	7.32	0.34	6.28	7.26
	2	8.23	0.44	7.62	8.80
	3	9.45	0.68	8.25	9.52
	4	10.67	0.94	8.25	9.52
	0.75	5.49	0.19	6.42	7.41
	1.0	6.71	0.27	5.96	6.89
3.79	1.5	7.32	0.37	6.99	8.07
	2	8.53	0.49	6.69	7.73
	3	9.75	0.74	7.75	8.95
	4	10.67	1.04	9.18	10.59

Precipitation rates calculated at 50% diameter spacing, half circle operation.



Rain Bird Sales, Inc.
970 W. Sierra Madre, Azusa, CA
91702 USA
Phone: (626)963-9311
Fax: (626)812-3411
Rain Bird Technical Services:
(800)247-3782

Rain Bird International, Inc.
145 North Grand Avenue
Glendora, CA 91741 USA
Phone: (626)963-9311
Fax: (626)963-4287

Rain Bird Sales, Inc.
4261 South Country Club Road
Tucson, AZ 85714 USA
Phone: (520) 741-6100
Fax: (520) 741-6146

♻️ Printed on recycled paper.
Rain Bird. Conserving More Than Water.

© Registered Trademark of Rain Bird Sprinkler Mfg. Corp.
© 2000 Rain Bird Sprinkler Mfg. Corp. 03/00

3500 Series Rotor
Aspersor de turbina de la serie 3500
Rotor da Série 3500
Irrigatore a Turbina Rain Bird Serie 3500
Rain Bird 3500 Series Rotor (Need French Translation)
Rain Bird Versenkregner Typenreihe 3500
Rain Bird 3500 Serie Turbinesproeier

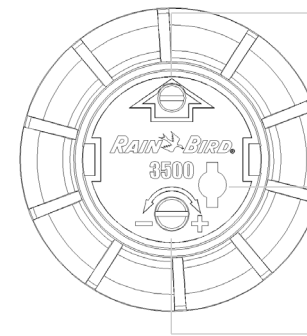
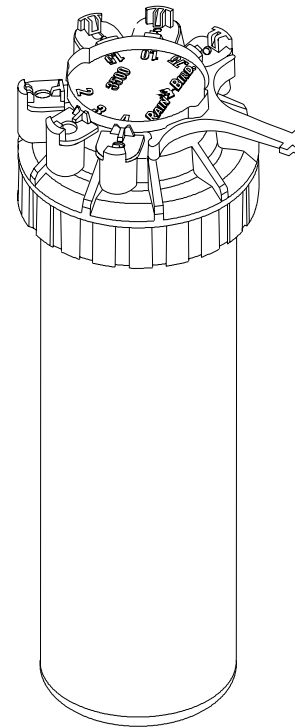

Nozzle identification
Tapón de identificación de la boquilla
Ranhura de elevação
Tappo di identificazione del bocaglio
Pastille d'identification de la buse
Düsen-Identifikationsstopfen
Nozzle-identificatie dop

Radius adjustment slot
Ranura de ajuste del radio
Ranhura de ajuste do raio
Alloggiamento di regolazione della gittata
Fente de réglage de portée
Strahlstör-/Halteschraube
Sleuf voor instellen van de sproeistraal

Pull-up slot
Ranura de levante
Ranhura de ajuste do arco de cobertura
Alloggiamento di sollevamento del pistone
Fente de levage
Öffnung zum Hochziehen
Sleuf voor optrekken van stijgbuis

Arc adjustment slot
Ranura de ajuste del arco de cobertura
Plugue de identificação do bocal
Alloggiamento di regolazione del settore
Sektoreneinstellschraube
Sleuf voor instellen van spreekhoek

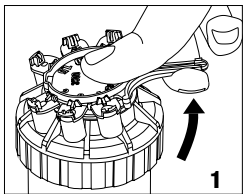

1. Remove nozzle TREE from rotor
2. Select desired nozzle
3. Lift-up stem
4. Installing nozzles: **a.** Insert nozzle, (press firmly until nozzle seats), **b.** Turn radius reduction screw to retain nozzle
5. Setting the arc: Arc is adjustable from 40-360 degrees. **a.** Find fixed LEFT edge, **b.** To increase arc, turn right (clockwise), **c.** To decrease arc, turn left (counterclockwise)

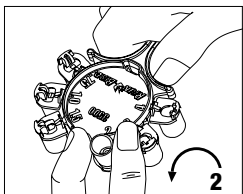

6. Removing nozzles
7. Cleaning filter screen: **a.** Remove internals from case, **b.** Remove Filter screen

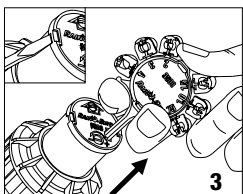

1. Remueva el portaboquilla "TREE" del aspersor de turbina
2. Seleccione la boquilla
3. Levante el vástago
4. La instalación de las boquillas: **a.** Introduzca la boquilla (presione firmemente hasta que la boquilla se asiente), **b.** Gire el tornillo de ajuste del radio para fijar la boquilla.
5. El reglaje del arco de cobertura: El arco de cobertura puede ser ajustado desde 40 hasta 360 grados. **a.** Ubique el borde izquierdo del punto de parada, **b.** Para aumentar el arco de cobertura, gire hacia la derecha (en el sentido de las manecillas del reloj), **c.** Para disminuir el arco de cobertura, gire hacia la izquierda (en el sentido contrario al de las manecillas del reloj).
6. Cómo se quitan las boquillas
7. La limpieza del filtro de malla: **a.** Remueva el mecanismo interno de la carcasa, **b.** Remueva el filtro de malla.

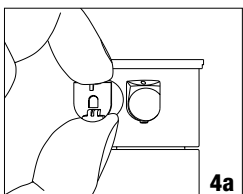

1. Remova o porta-bocais "TREE" do rotor
2. Selecione o bocal desejado
3. Levante a haste
4. Instalação dos bocais: **a.** Insira o bocal (pressione firmemente até ele ficar bem assentado), **b.** Gire o parafuso de redução para fixar o bocal.
5. Configuração do arco de cobertura: o arco de cobertura pode ser ajustado de 40 a 360 graus. **a.** Encontre a borda esquerda do ponto de parada fixa, **b.** Para aumentar o arco de cobertura, gire para a direita (sentido horário), **c.** Para reduzir o arco de cobertura, gire para a esquerda (sentido anti-horário).
6. Remoção de bocais
7. Limpeza da tela de filtro. **a.** Remova a parte interna da carcaça, **b.** Remova a tela de filtro

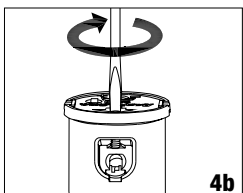

1. Staccare il i boccagli dall'irrigatore
2. Scegliere il boccaglio desiderato
3. Sollevare il pistone
4. Installazione dei boccagli: **a.** Inserire il boccaglio (premere fortemente per posizionare il boccaglio), **b.** Avvitare la vite di regolazione delle gittata per bloccare il boccaglio.
5. Regolazione del settore: Il settore è regolabile da 40° a 360°. **a.** Trovare il punto fermo sinistro, **b.** Girare il cacciavite in senso orario per aumentare il settore, **c.** Girare il cacciavite in senso antiorario per aumentare il settore.

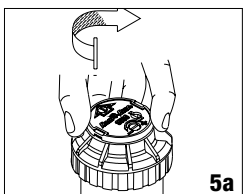

6. Rimozione dei boccagli
7. Pulizia del filtro: **a.** Rimuovere in meccanismo interno dal corpo dell'irrigatore **b.** Rimuovere il filtro

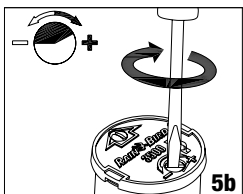

1. Enlever la grappe de buses du rotor
2. Choisir la buse désirée
3. Tirer la tige de l'arroseur
4. Installation des buses: **a.** Insérer la buse (presser fortement), **b.** Tourner le vis brise-jet pour bloquer la buse
5. Réglage du secteur arrosé: de 40 à 360 degrés: **a.** Repérer la butée gauche, **b.** Pour accroître le secteur arrosé, toner dans le sens des aiguilles d'une montre, **c.** Pour diminuer le secteur, toner en sens inverse des aiguilles d'une montre
6. Pour enlever les buses
7. Nettoyage du filtre: **a.** Enlever la partie interne, **b.** Enlever le filtre

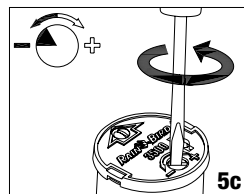

1. Nehmen Sie den Düsenatz vom Regner ab
2. Wählen Sie die gewünschte Düse
3. Ziehen Sie den Aufsteiger hoch
4. Einsetzen der Düsen: **a.** Setzen Sie die Düse fest ein, **b.** Drehen Sie die Strahlstör-/Halteschraube, um die Düse zu arretieren
5. Sektoreneinstellung: der Sektor ist von 40° bis 360° einstellbar: **a.** Suchen Sie den fixierten LINKEN Anschlag, **b.** Um den Sektor zu vergrößern, drehen Sie die Schraube nach rechts (in Uhrzeigerrichtung), **c.** Um den Sektor zu verkleinern, drehen Sie die Schraube nach links (gegen die Uhrzeigerrichtung)

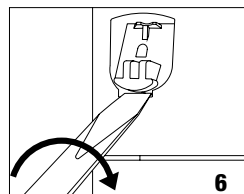

6. Herausnehmen der Düsen
7. Reinigen des Filters: **a.** Nehmen Sie das Innenteil heraus, **b.** Ziehen Sie den Filter heraus

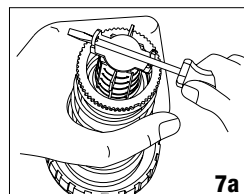

1. Verwijder de nozzleboom van de sproeier
2. Kies de gewenste nozzle
3. Trek de stijgbuis omhoog
4. Installeren van de nozzles: **a.** Schuif de nozzle in de daartoe bestemde opening (druk door tot de nozzle goed op zijn plaats zit), **b.** Draai de afstelschroef om de nozzle vast te zetten
5. Instellen van de sproeihoek: Sproeihoek is afstelbaar van 40-360 graden. **a.** Zoek het vaste LINKER omkeerpunt, **b.** Om de sproeihoek te vergroten, draai rechtsom (met de klok mee) **c.** Om de sproeihoek te verkleinen, draai linksom (tegen de klok in)

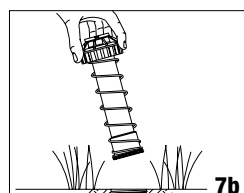

6. Verwijderen van de nozzles
7. Schoonmaken van het filter. **a.** Verwijder het binnenwerk uit de doos **b.** Verwijder het filter

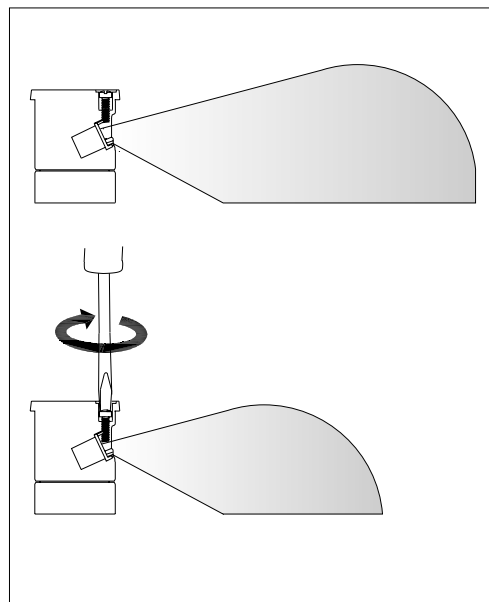

Radius reduction up to 35%
 Sproeistraal vermindering tot 35%
 La portée peut être réduite de 35%
 Die Wurfweite kann bis zu 35% verringert werden
 Riduzione della gittata fino al 35%
 Redução do raio de até 35%
 Se puede reducir el radio hasta un 35%